

MCBERNS

INNOVATIVE SOLUTIONS

MANUP KEY

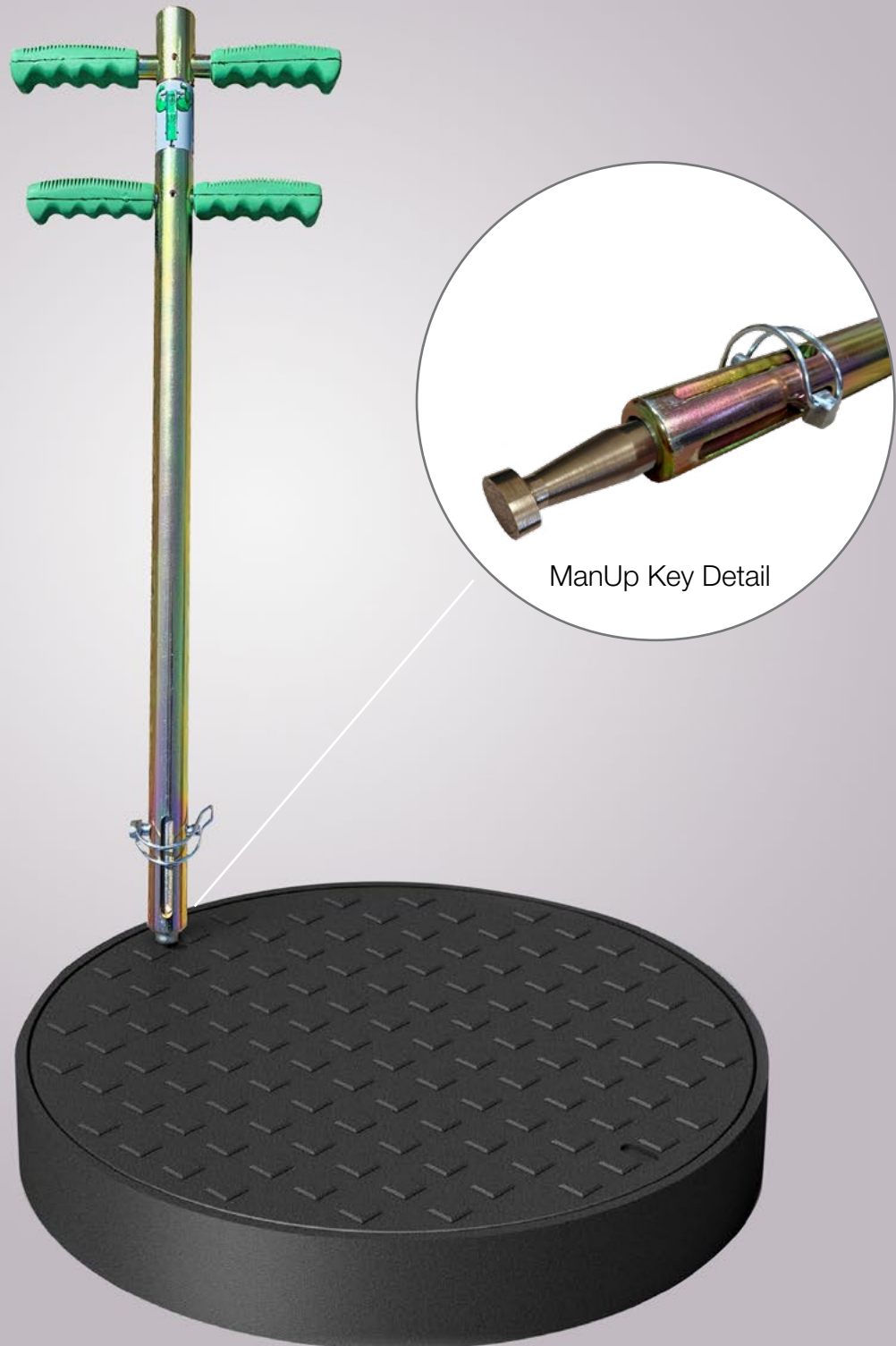

ManUp Key Detail

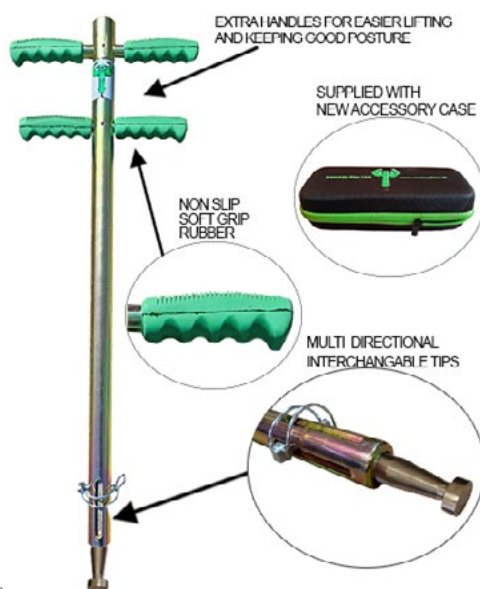

ManUp Key

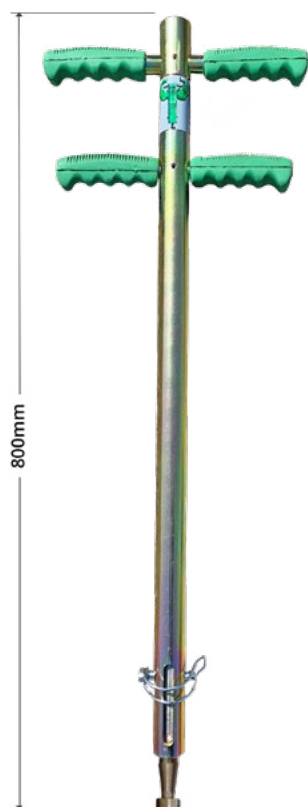

Part Number	MANUPKEY
Description	Tool complete with 3 x tips = 1 x hook and 2 x oval tips
Application	Fits any access cover with a keyhole size of approximately 20mm
Weight	8kg

ManUp Key Accessories

31mm oval Tip

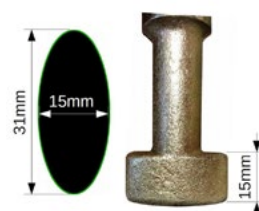

Part Number	008O30
Dimensions (L x D)	160 x 20mm
Head Size	31mm (L) x 15mm (D) Oval Shape
Weight	0.3kg
Material	Steel
Application	Fits any manhole or access cover with a 31mm x 15mm oval shaped keyhole

20mm Oval Tip

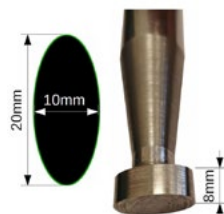

Part Number	009O20
Dimensions (L x D)	160 x 20mm
Head Size	20mm x 10mm oval Shape
Weight	0.3kg
Material	Steel
Application	Fits any access cover with a 20mm x 10mm oval shaped keyhole

8mm Hooked Tip

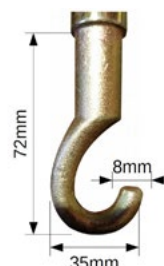

Part Number	010CHK
Dimensions (L x D)	182 x 20mm
Head Size	8mm hook
Weight	0.3kg
Material	Steel
Class	Light Duty
Application	Generally used within the Australian market, 8mm 'C' Shaped Hook for use in many different kinds of light gully covers

ManUp Valve Key Kit

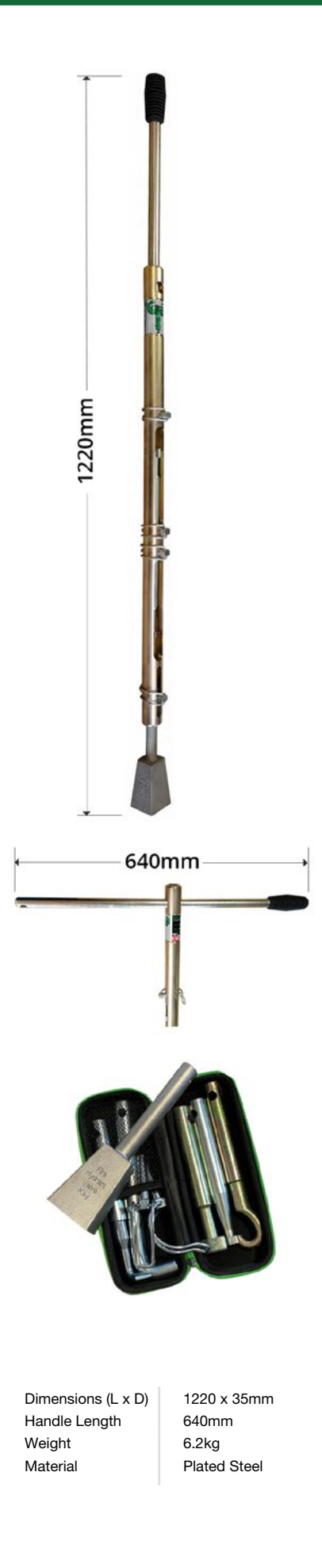

ManUp Valve Key Kit Inclusions



1220mm

640mm

Dimensions (L x D) 1220 x 35mm
 Handle Length 640mm
 Weight 6.2kg
 Material Plated Steel

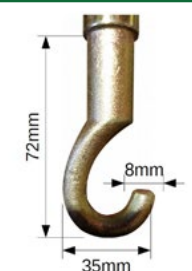
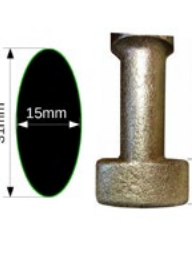
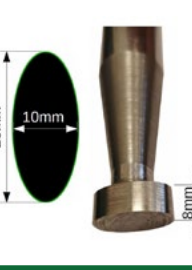
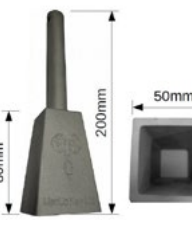
	<h3>Cleaning Tip – 006J08</h3> <p>Dimensions (L x D) 174 x 20mm Head Size tapered Point Weight 0.3kg Material Steel Class Light Duty Application A pointed hook, ideal for cleaning out the dirt and grit that becomes clogged in access cover keyholes over time.</p>	<p>Usage</p> <ul style="list-style-type: none"> Drainage Gas Electricity Telecoms Pest Control Fire Service Drinking Water
	<h3>10mm J Tip – 007J10</h3> <p>Dimensions (L x D) 174 x 20mm Head Size 20mm (L) x 10mm (D) 'J' Shape Weight 0.3kg Material Steel Class Medium Duty Application A 10mm j shaped hook can be used on many different types of access covers and gulleys.</p>	<p>Usage</p> <ul style="list-style-type: none"> Drainage Gas Electricity Telecoms Pest Control Fire Service Drinking Water
	<h3>8mm Hooked Tip – 010CHK</h3> <p>Dimensions (L x D) 182 x 20mm Head Size 8mm Hook Weight 0.3kg Material Steel Class Light Duty Application Generally used within the Australian market, 8mm 'C' Shaped Hook for use in many different kinds of light gully covers</p>	<p>Usage</p> <ul style="list-style-type: none"> Drainage
	<h3>31mm Oval Tip – 008O30</h3> <p>Dimensions (L x D) 160 x 20mm Head Size 31mm (L) x 15mm (D) Oval Shape Weight 0.3kg Material Steel Class Light Duty Application Fits any manhole or access cover with a 31mm x 15mm oval shaped keyhole.</p>	<p>Usage</p> <ul style="list-style-type: none"> Drainage
	<h3>20mm Oval Tip – 009O20</h3> <p>Dimensions (L x D) 160 x 20mm Head Size 20mm x 10mm oval Shape Weight 0.3kg Material Steel Class Light Duty Application Fits any access cover with a 20mm x 10mm oval shaped keyhole</p>	<p>Usage</p> <ul style="list-style-type: none"> Drainage Gas Electricity Telecoms Pest Control Fire Service Drinking Water
	<h3>Fire Hydrant Valve Key – 011HYD</h3> <p>Dimensions (L x D) 200 x 20mm Head Size 50mm x 50mm Tapered Square Weight 0.5kg Material Case Steel Class Heavy Duty Application The stop tap valve key, designed specifically for use with the ManUp Key's slide hammer action to prevent the key getting stuck on valves</p>	<p>Usage</p> <ul style="list-style-type: none"> Fire Service Drinking Water

Retaining Pin

Linch pin generally used in The ManUp Key bar to retain the tips to the tool Each ManUp Key kit includes 2 x Retaining pins



Accessories case

Included with every complete kit



ManUp Key User Guide

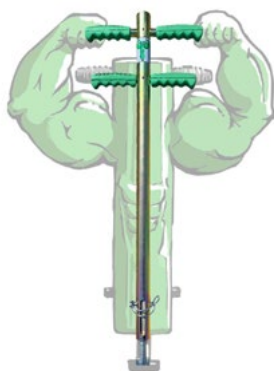

How to use the ManUp Key

1. Always ensure your ManUp Key is in good condition and set up properly before use. The interchangeable tips and locking pin will eventually show signs of wear after repeated use. Replace these parts accordingly.
2. Make sure you've cleared the area around the manhole, moving and avoiding any potential trip hazards.
3. Select the tip most suited for the manhole you intend to lift. Secure the tip in place by using the locking pin.
4. Insert the tip of the ManUp Key into the key slot of the manhole. Turn the key 90° to lock it in place. Do not lean over, bend or use the ManUp Key as a lever at any time.
5. If you find that you are not standing square to the cover, try removing the tip from the ManUp Key, rotating it 90°, and securing back in place with the locking pin.
6. Stand in front of the manhole with a straight back and your legs parallel to your hips. Do not stand on the manhole.
7. Select the pair of handles which you find most comfortable to use, and taking a firm grip of both handles, lift with a sharp upward action using only your arms. The ManUp Key will travel upwards exerting a hammer-like effect on the manhole. This may need to be repeated several times to release more resistant manholes.
8. Once the manhole has been freed, you may use the lower handles of the ManUp Key to remove some lightweight covers. Larger, heavier covers may need alternative lifting equipment.

Important information

1. This key is designed to release manholes that are stuck. It may be used to lift some smaller, lighter covers, however larger and heavier covers may need alternative lifting equipment.
2. **DO NOT** use the key if you can see damage to the key or tip, or if there are any parts missing as this may result in injury.
3. **DO NOT** use the key if you are suffering from any health condition which may be worsened by strenuous activity.
4. **ONLY** use genuine ManUp Key tips. Replace tips immediately if they become damaged. Do not attempt to repair / weld broken tips. Genuine ManUp Key tips are specially forged.
5. The ManUp Key is designed to be used by only 1 person at any given time.
6. **DO NOT** hit the key with any other tool or device.
7. Never attempt to repair the ManUp Key yourself.

MCBERNS

INNOVATIVE SOLUTIONS

ODOUR MANAGEMENT
SAFETY ACCESS COVERS
DESIGN & FABRICATION
DATA ANALYTICS

MCBERNS PTY LTD
ABN: 56 060 984 107
Address: 11 Tectonic Crescent,
Kunda Park, Qld, 4556
Phone: +61 7 5445 1646
Fax: +61 7 5445 1743
Email: mail@mcbarns.com

Stuart Darby: 0413 436 683